

M7727 SERIES

SINGLE-OUTPUT, 500W (750W PEAK*) DC TO DC BASEPLATE COOLED POWER SUPPLY

The M7727 is a series of mechanically robust, base-plate cooled, high performance, power supplies, designed for Ground Mobile (MIL-STD-1275), Airborne (MIL-STD-704) and other Hi-Reliability applications where 28VDC has to be converted to a tightly regulated, filtered and protected DC output.



*For output voltage above 24Vdc

M7727 Series– DC/DC Power Supply

Standard Models List (for other voltages – consult factory)

Part Number	Input	Output		Power	Special features
	Voltage range	Voltage	Current		
M7727-100	18 to 50 V _{DC}	12 V _{DC}	40 A	480W	Peak Power 540W for 2 sec
M7727-101	18 to 50 V _{DC}	15 V _{DC}	33 A	495W	Peak Power 600W for 2 sec
M7727-102	18 to 50 V _{DC}	24 V _{DC}	21 A	504W	
M7727-103	18 to 50 V _{DC}	28 V _{DC}	18 A	504W	
M7727-104	18 to 50 V _{DC}	48 V _{DC}	10.5A	504W	
M7727-106	18 to 50 V _{DC}	28 V _{DC}	18A	504W	Parallel operation via output voltage droop. Voltage regulation is ±2%.
M7727-800	18 to 50 VDC	12 VDC	40 A	480W	Peak Power 540W for 2 sec
M7727-801	18 to 50 VDC	15 VDC	33 A	495W	Peak Power 600W for 2 sec
M7727-802	18 to 50 VDC	24 VDC	21 A	504W	
M7727-803	18 to 50 VDC	28 VDC	18 A	504W	
M7727-804	18 to 50 VDC	48 VDC	10.5A	504W	
M7727-806	18 to 50 VDC	28 VDC	18A	504W	Parallel operation via output voltage droop. Voltage regulation is ±2%.

Notes For M7727-8XX:

- This Product is REACH Compliant.
 - The aluminum parts comprising this converter are chromate conversion coated per MIL-DTL-5541F, Type II CLASS 1A or eq.
 - Connector Type: M24308/24-40Z or eg.
-
- Additional standard configurations available. **Contact factory for more details.**

M7727 Series– DC/DC Power Supply

THE MAIN FEATURES OF THE M7727 ARE:

- DC/DC Single outputs power supply up to 500W
- 750W Power peak for 4 sec for output voltage above 24Vdc
- 600W peak power for 2 sec for output voltage below 24Vdc
- 18 to 50VDC Standard Input version
- For standard Input version No damage due to abnormal transients IAW MIL-STD-1275A (100 V / 50 ms) and MIL-STD-704A (80 V / 0.1 s)
- For extended input version 12 to 100VDC operation - **Please contact factory for more details**
- High efficiency – up to 90% (depending on output voltage).
- Full galvanic isolation between Input, Chassis and Outputs
- External Inhibit (On/Off)
- Fixed switching freq. (250 kHz)
- EMI filters included
- Remote sense compensation
- Indefinite short circuit protection with auto-recovery
- Over-voltage protection
- Over temperature shutdown with auto-recovery
- High density
- Conduction cooled via the baseplate

M7727 Series– DC/DC Power Supply

SPECIFICATIONS:

DC Input	Voltage Range	18 to 50 V _{DC} Extended input range option: 12 to 100 V _{DC} IAW MIL-STD-1275E
	Isolation	Input to Output: 200 VDC Input to Case: 200 VDC
	Input Reverse Polarity	Protection for unlimited time
	Under-Voltage Lock-Out	The unit shuts down below 15V ± 1V*. Resumes operation at 17V ± 1V*. Min. hysteresis 2V*. *Estimated values.
	Over-Voltage Lock-Out	The unit shuts down above 55V ± 4V. <u>Optional:</u> At 12-100V input unit shuts down 105 ± 2V
DC Output	Rating	See table on page 9
	Voltage Regulation	Better than or equal to ±1% (low to high line voltage, no load to full load, –55 °C to +85 °C at baseplate).
	Remote Sense	The SENSE is used to achieve accurate load regulations at load terminals (this is done by connecting the pins directly to the load's terminals). For output voltage above 8V, the use of remote sense has a max limit of 0.25V voltage dropout between converter's output and load terminals. For output voltage below 8V, the use of remote sense has a max limit of 0.5V voltage dropout between converter's output and load terminals. When not used connect SENSE 1 to OUT 1 and SENSE 1 RTN to OUT 1 RTN.
	Ripple	Less than 50 mVp-p, typical (max. 1% of output voltage)
	Isolation	Output to Case: 100 VDC

M7727 Series– DC/DC Power Supply

<i>Overvoltage Protection</i>	<ul style="list-style-type: none"> • Active Over-Voltage Protection: The secondary control circuit takes the over if output voltage exceeds $110\% \pm 5\%$ of nominal voltage. Beyond this, output voltage clamps. • Passive Over-Voltage Protection: Zener diode installed on output terminals, selected at $120\% \pm 10\%$ of nominal voltage.
<i>Peak Load Duration Limiter</i>	<p>For output voltage above 24V: Peak load 750W is enabled for up to 4 seconds. Beyond this, output voltage folds to limit the output power to the nominal value.</p> <p>For output voltage below 24Vdc: Peak load 600W is enabled for up to 2 seconds. Beyond this, output voltage folds to limit the output power to the nominal value.</p>
<i>Efficiency</i>	<p>Typical: 88% - 90%</p> <p>Extended input range: 83% - 86% (28V_{DC} output, nominal input, full load, room temperature)</p>
<i>Current Limit & Overload</i>	<p>Output voltage turns off and on periodically with low duty cycle (hiccup) to protect system conductors and converter from short circuit</p>
<i>Over Temp. Protection</i>	<p>Output shuts down if base plate temperature exceeds $+105^{\circ}\text{C} \pm 5^{\circ}\text{C}$. Automatic recovery when baseplate temperature returns to below $+95^{\circ}\text{C} \pm 5^{\circ}\text{C}$.</p>

M7727 Series– DC/DC Power Supply

Specifications (Cont.):

Control & Indication	<i>INHIBIT Signal</i>	<p>The INHIBIT signal is used to turn the power supply ON and OFF. To turn the power supply OFF, apply a TTL “0” signal or SHORT to SIGNAL RTN.</p> <p>To turn the power supply ON, apply a TTL “1” signal or leave this pin OPEN.</p> <p>If not used (always ON), leave this pin OPEN.</p> <p>This signal is referenced to SIGNAL RTN.</p> <p>ENABLE Signal - Optional - Please consult factory.</p> <p>To turn the power supply OFF, apply a TTL “1” signal or leave this pin OPEN.</p> <p>To turn the power supply ON, apply a TTL “0” signal or SHORT to SIGNAL RTN.</p>
	<i>SYNC IN</i>	<p>The SYNC IN signal is used to allow the power supply frequency to sync with the system frequency.</p> <p>The system frequency should be 250 kHz ± 10 kHz.</p> <p>When not connected the power supply will work at 250 kHz ± 10 kHz.</p> <p>This signal is referenced to SIGNAL RTN</p>
	<i>SIGNAL RTN</i>	<p>INHIBIT and SYNC signals are referenced to this pin.</p> <p>This pin is referenced to IN RTN.</p>
	<i>POR Optional</i>	<p>Protection Override signal (BATTLE SHORT function) overrides over temperature protection and input over/under-voltage lock-out</p>
Environment Designed to meet MIL-STD-810F	<i>Temperature</i>	<p>Methods 501.4 & 502.4</p> <p>Operating: –55 °C to +85 °C (at baseplate)</p> <p>Storage: –55 °C to +125 °C (ambient)</p>
	<i>Humidity</i>	<p>Method 507.4</p> <p>Up to 95% RH</p>
	<i>Salt-fog</i>	<p>Method 509.4</p>
	<i>Altitude</i>	<p>Method 500.4</p> <p>Procedures I – Storage/Air transport: up to 70,000 ft. (non-operational)</p> <p>Procedure II – Operation/Air Carriage: up to 70,000 ft. (operational)</p>
	<i>Mechanical Shock</i>	<p>Method 516.5</p> <p>Procedure I</p> <p>50 g / 11 ms terminal peak half-sine shock pulse</p>

M7727 Series– DC/DC Power Supply

	Vibration	Method 514.5 Procedure I 14.76 g _{rms} 20-2000 Hz for 500 seconds at each of 3 perpendicular axes.
	Fungus	Does not support fungus growth, in accordance with the guidelines of MIL-STD-454, Requirement 4-
EMI	MIL-STD-461F	Meets* MIL-STD-461F CE101, CE102, CS101, CS114, CS115, CS116, RE101, RE102, RS101, RS103 *EMI Compliance achieved with 5μH LISN, shielded harness and static resistive load. (Optional: 50 μH – Please consult factory)
Reliability	150,000 hours, calculated per MIL-HDBK-217F Notice 2 at +85 °C baseplate, Ground Fix conditions.	
Cooling Requirements	The M7727 is a baseplate cooled unit. The base of the M7727 should be thermally attached to a suitable heatsink that maintains it below +85 °C.	
Form factor	2.76" wide, 0.81" high and 5.31" deep. For detailed dimensions and tolerances see Drawing: M7727001.	
Weight	Approx. 14.1 oz [400 g]	
Connectors	Connector type: M24308/24-34F or eq. Mates with: M24308/2-4F or eq.	

M7727 Series— DC/DC Power Supply

TYPICAL CONNECTION DIAGRAM

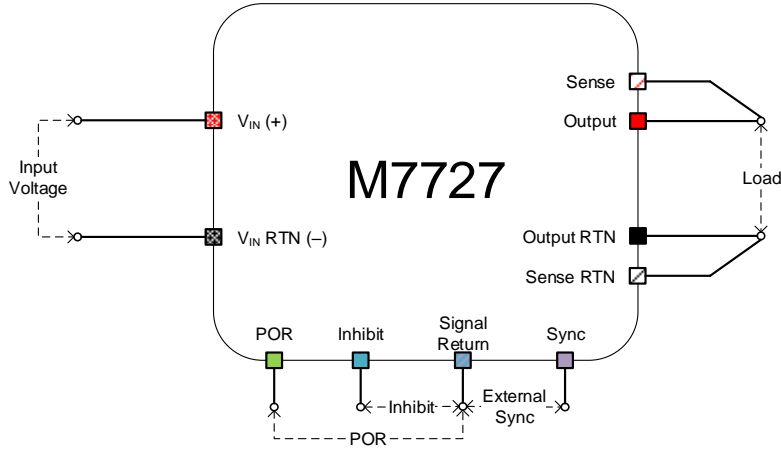

M7727 Series– DC/DC Power Supply

PARALLEL OPERATION - TYPICAL CONNECTION DIAGRAM

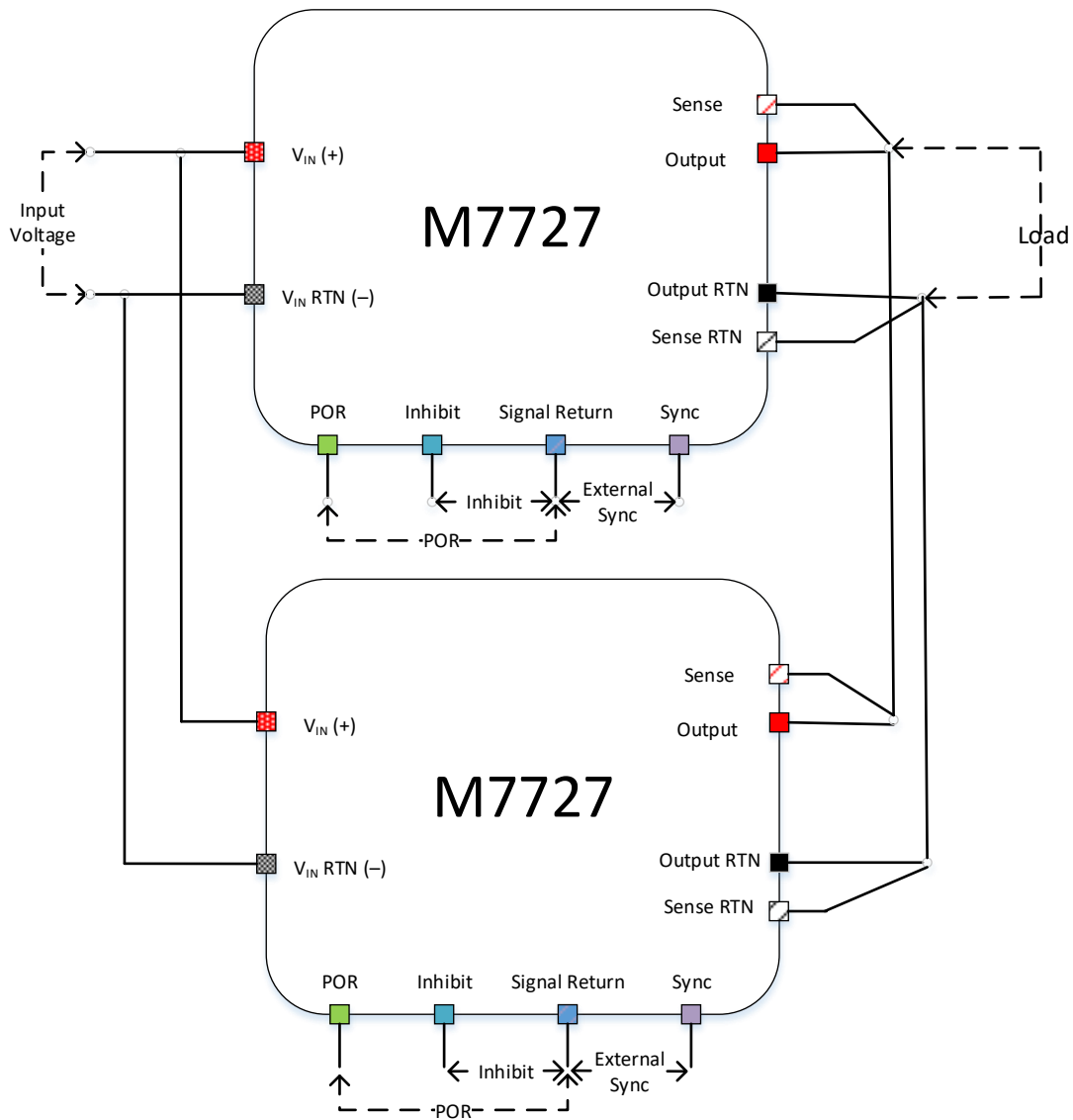

Note: Parallel operation via output voltage droop. Voltage regulation is $\pm 2\%$.

Outputs Range

Output #	Voltage Range	Current Range	Output Regulation	Power Range
1	12 to 50 V _{DC}	40A max	$\pm 1\%$	500W max

TEST RESULTS:

Table 5.3: CE102 Ambient noise measurement results, -28 VDC

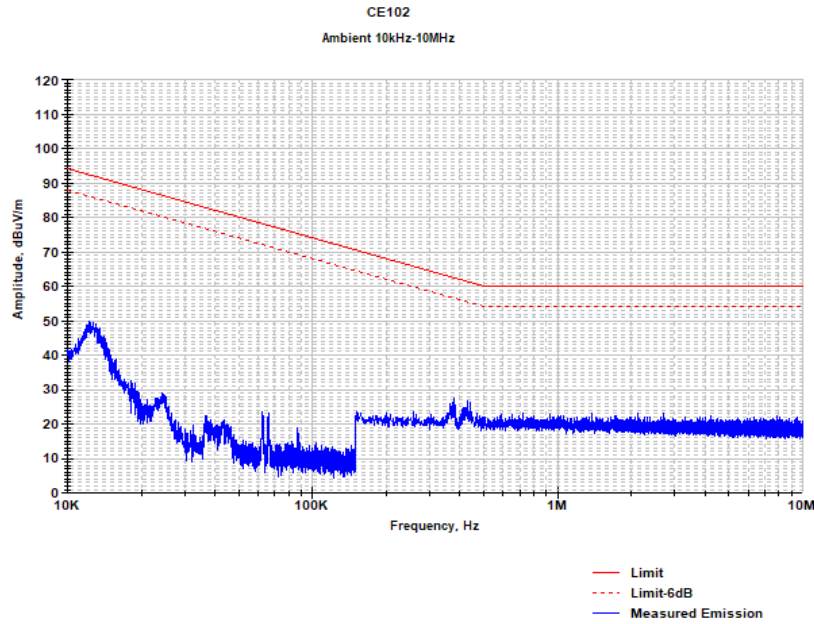

Table 5.5: CE102 Test results, -28 VDC

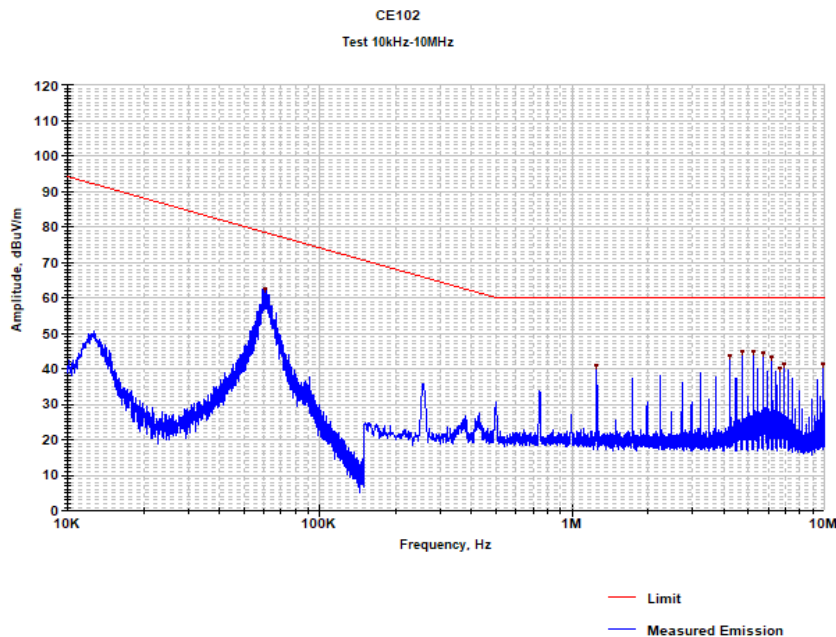

Table 5.3: CE102 Ambient noise measurement results, -28 VDC

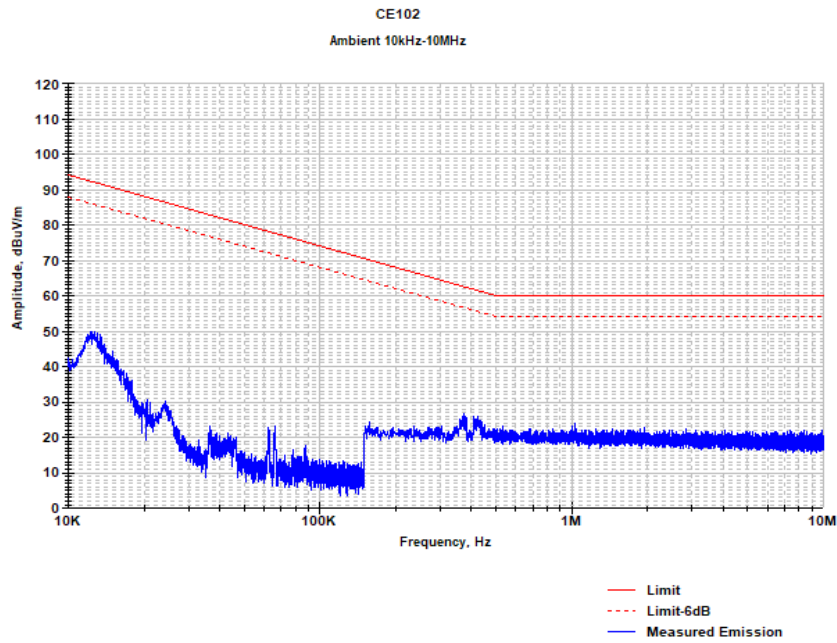
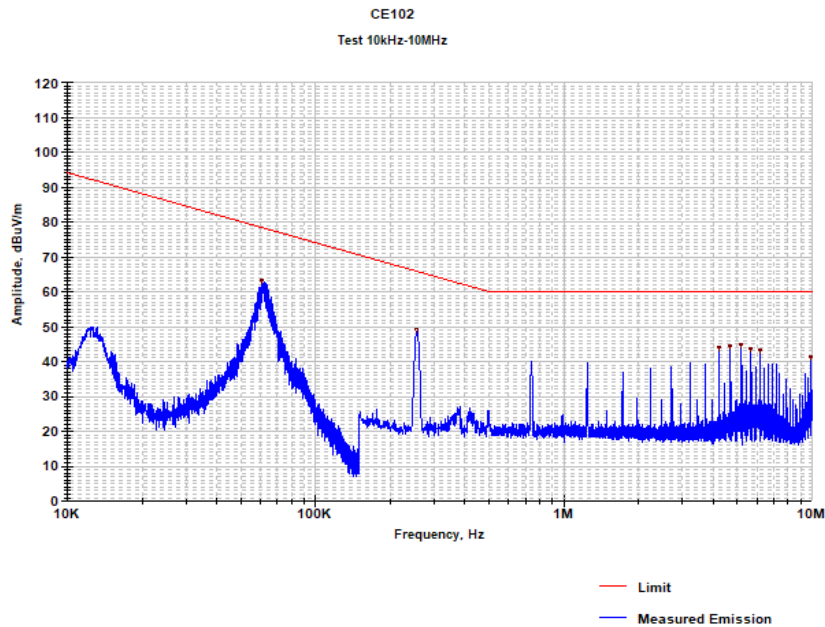
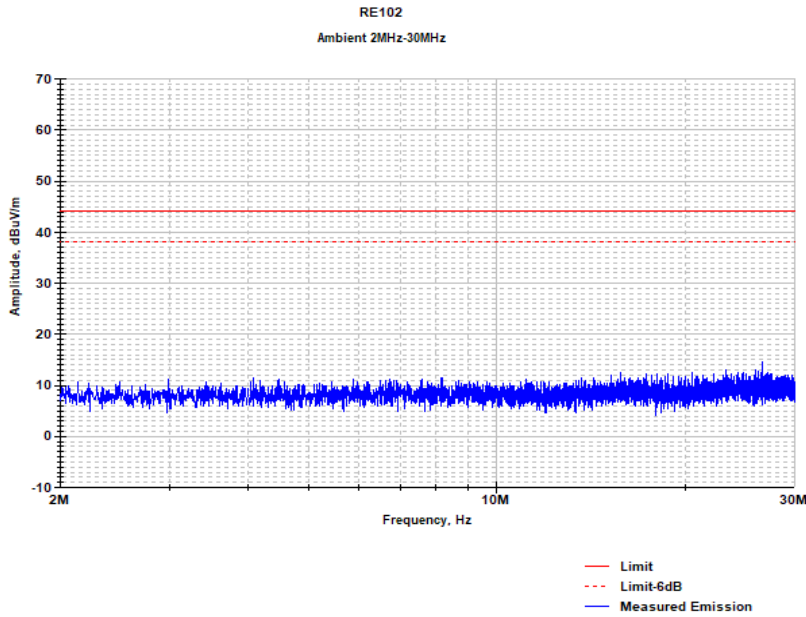

Table 5.5: CE102 Test results, +28 VDC



M7727 Series– DC/DC Power Supply

Plot 11.8: RE102, ambient noise within 2 – 30 MHz, vertical polarization



Display line is Limit

Plot 11.9: RE102 test results within 2 – 30 MHz, vertical polarization

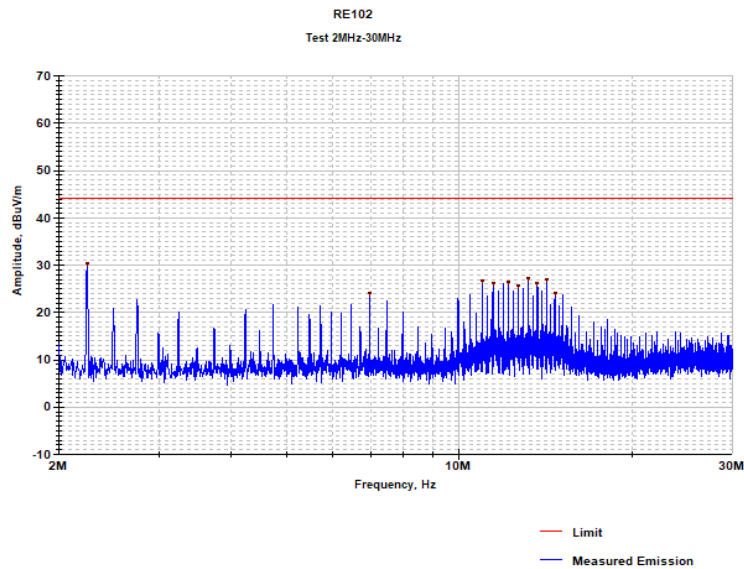

Display line is Limit

M7727 Series– DC/DC Power Supply

Plot 11.12: RE102, ambient noise within 30 – 200 MHz, vertical polarization

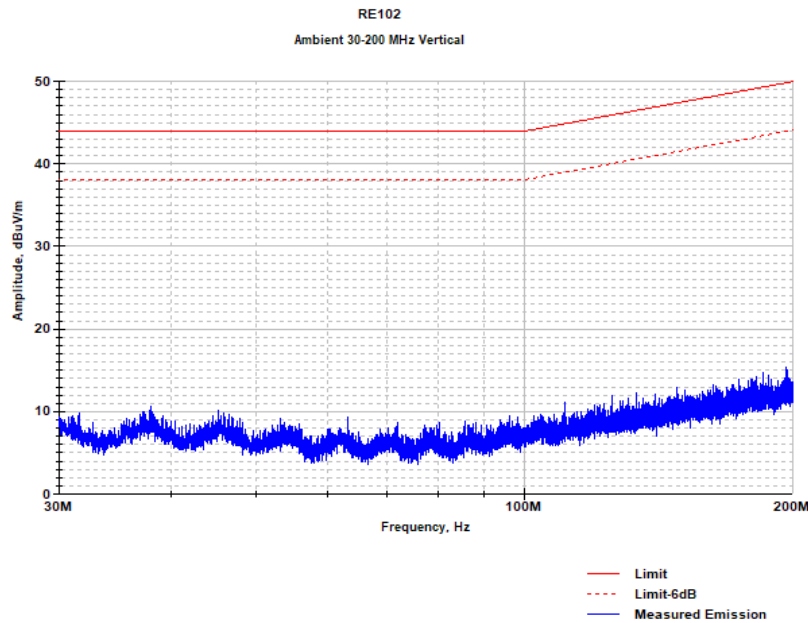

Display line is Limit

Plot 11.14: RE102 test results within 30 – 200 MHz, vertical polarization

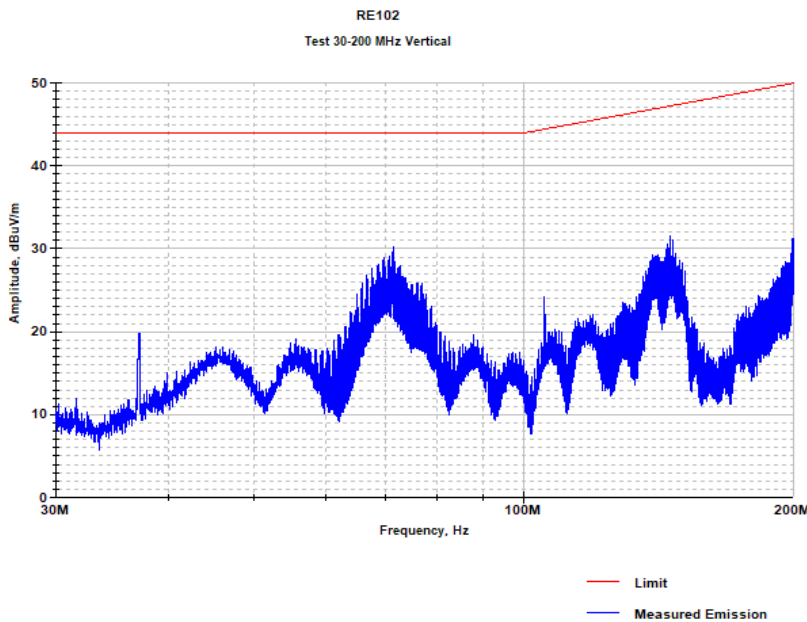

Display line is Limit

M7727 Series– DC/DC Power Supply

Plot 11.13: RE102, ambient noise within 30 – 200 MHz, horizontal polarization

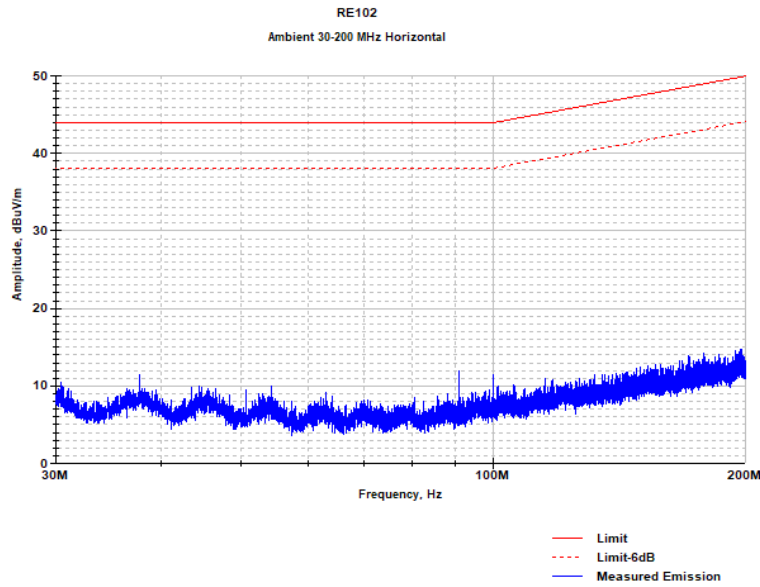

Display line is Limit

Plot 11.15: RE102 test results within 30 – 200 MHz, horizontal polarization

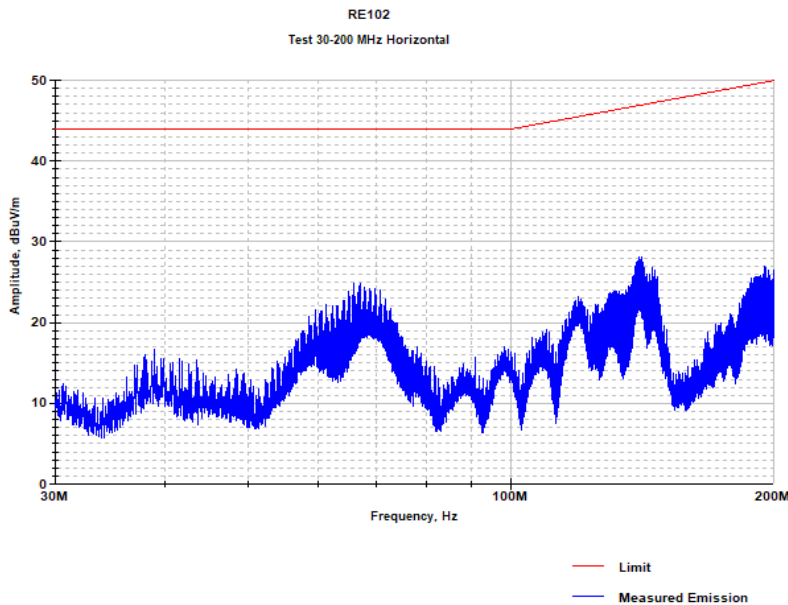

Display line is Limit

M7727 Series– DC/DC Power Supply

Plot 11.18: RE102 ambient noise within 200 – 1000 MHz, vertical polarization

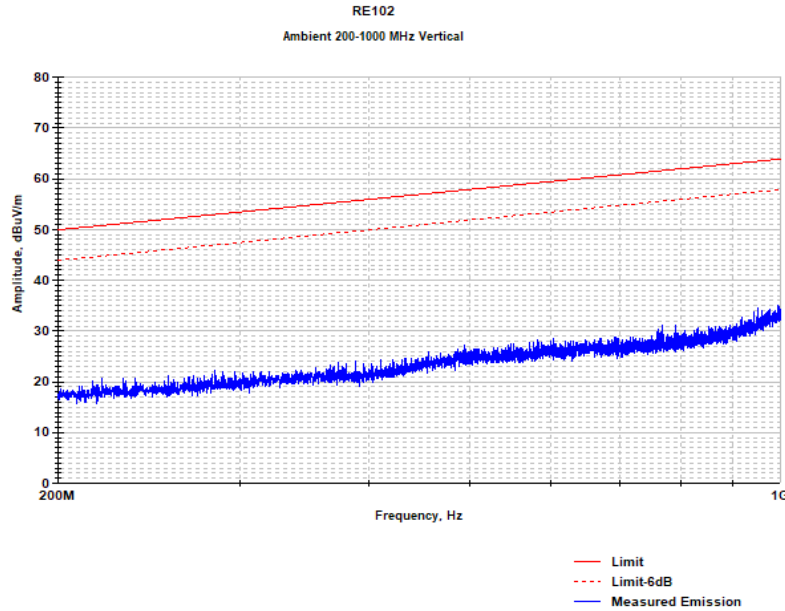

Display line is Limit

Plot 11.19: RE102 test results within 200 – 1000 MHz, vertical polarization

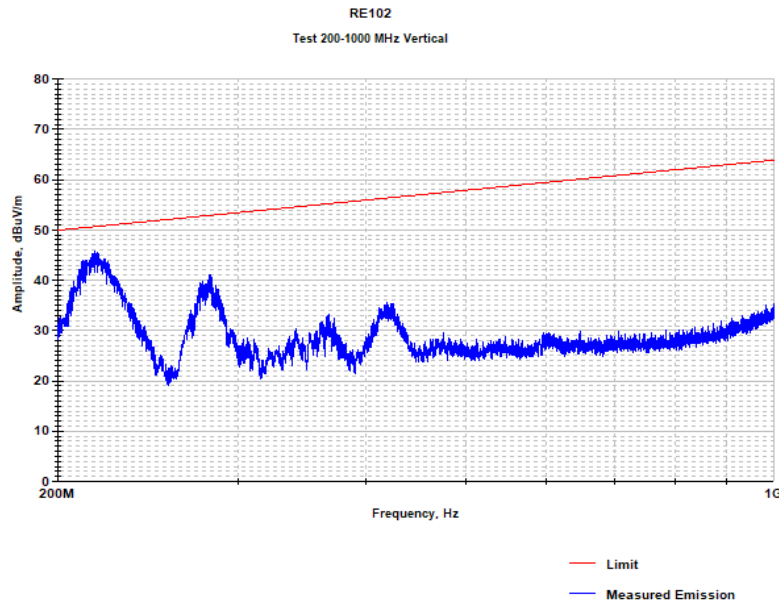

Display line is Limit

M7727 Series– DC/DC Power Supply

Plot 11.20: RE102 ambient noise within 200 – 1000 MHz, horizontal polarization

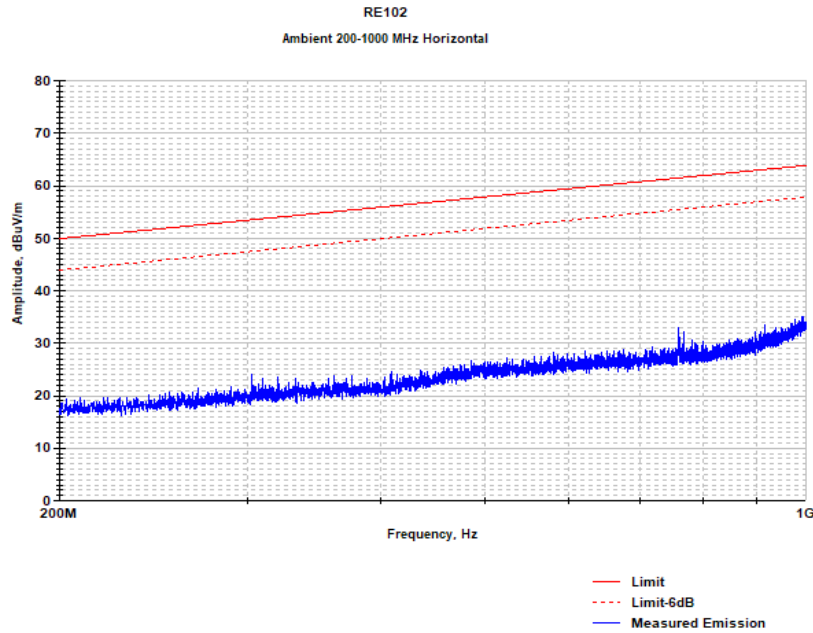

Display line is Limit

Plot 11.21: RE102 test results within 200 – 1000 MHz, horizontal polarization

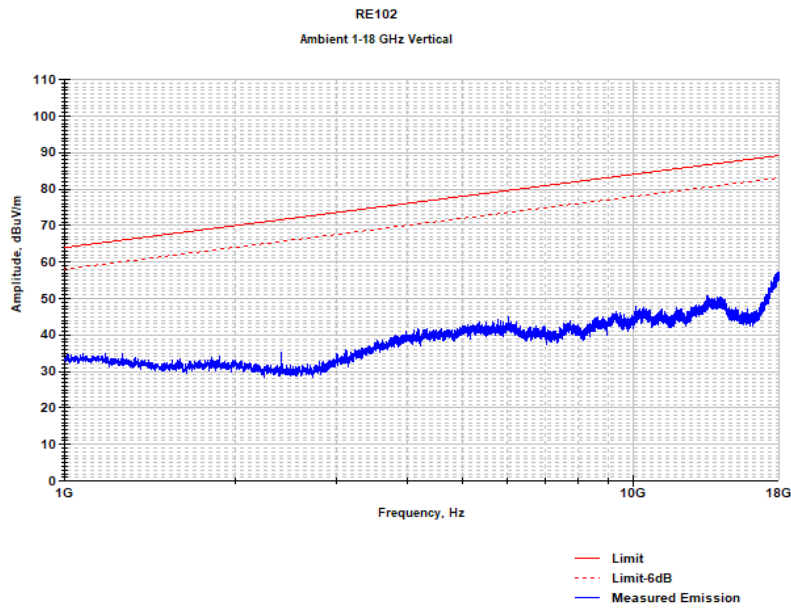

Display line is Limit

M7727 Series– DC/DC Power Supply

Plot 11.24: RE102 ambient noise within 1000 – 18000 MHz, vertical polarization

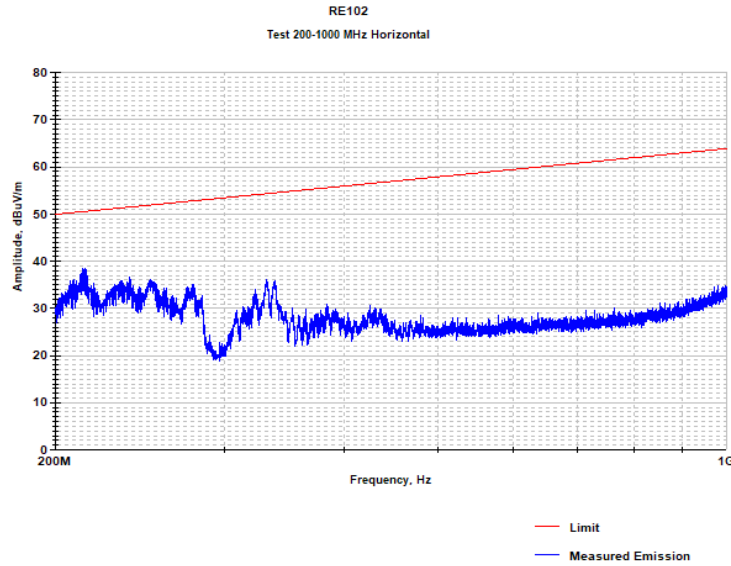

Display line is Limit

Plot 11.25: RE102 test results within 1000 – 18000 MHz, vertical polarization

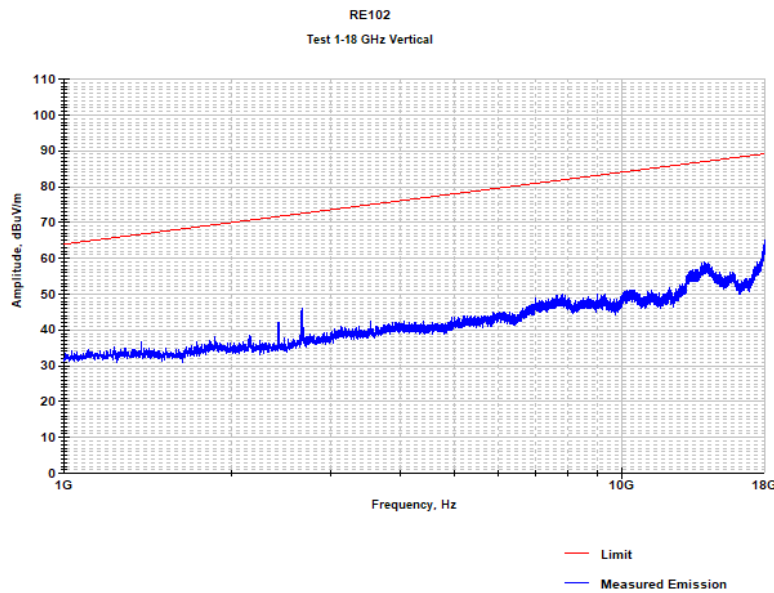

Display line is Limit

M7727 Series– DC/DC Power Supply

Plot 11.24: RE102 ambient noise within 1000 – 18000 MHz, horizontal polarization

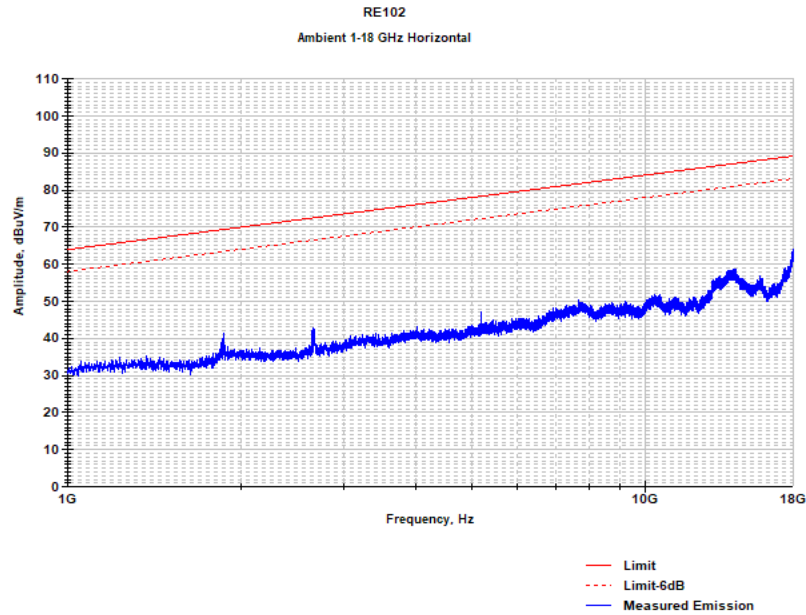

Display line is Limit

Plot 11.25: RE102 test results within 1000 – 18000 MHz, horizontal polarization

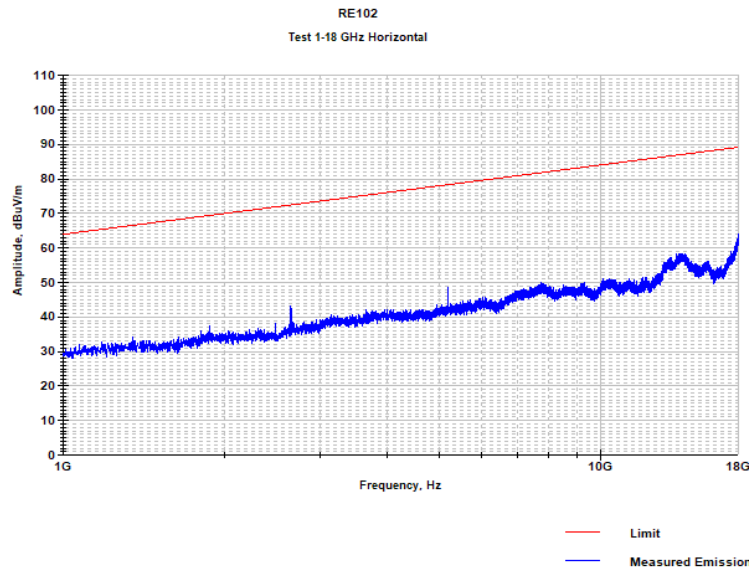

Display line is Limit

M7727 Series– DC/DC Power Supply

PIN ASSIGNMENT:

Connector type: M24308/24-34F or eq.

Mates with: M24308/2-4F or eq.

Pin No.	Function	P		Pin No.	Function	P		Pin No.	Function	P	
1	SENSE	+	●	14	IN RTN	-	●	27	OUT RTN	-	●
2	OUT	+	●	15	IN RTN	-	●	28	OUT RTN	-	●
3	OUT	+	●	16	N.C.			29	SYNC IN		
4	OUT	+	●	17	N.C.			30	IN	+	●
5	OUT RTN	-	●	18	N.C.			31	IN	+	●
6	OUT RTN	-	●	19	N.C.			32	IN	+	●
7	OUT RTN	-	●	20	OUT	+	●	33	IN RTN	-	●
8	OUT RTN	-	●	21	OUT	+	●	34	IN RTN	-	●
9	SENSE RTN	-		22	OUT	+	●	35	IN RTN	-	●
10	N.C.			23	OUT	+	●	36	POR	+	
11	INHIBIT			24	OUT	+	●	37	SIGNAL RTN	-	
12	IN	+	●	25	OUT RTN	-	●				
13	IN	+	●	26	OUT RTN	-	●				

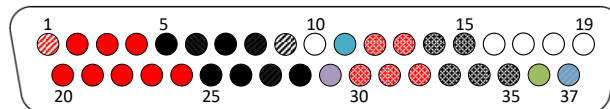

Note: All pins with identical function/designation should be connected together for optimal performance.

M7727 Series– DC/DC Power Supply

OUTLINE DRAWING:

For detailed dimensions and tolerances see Drawing: M7727001

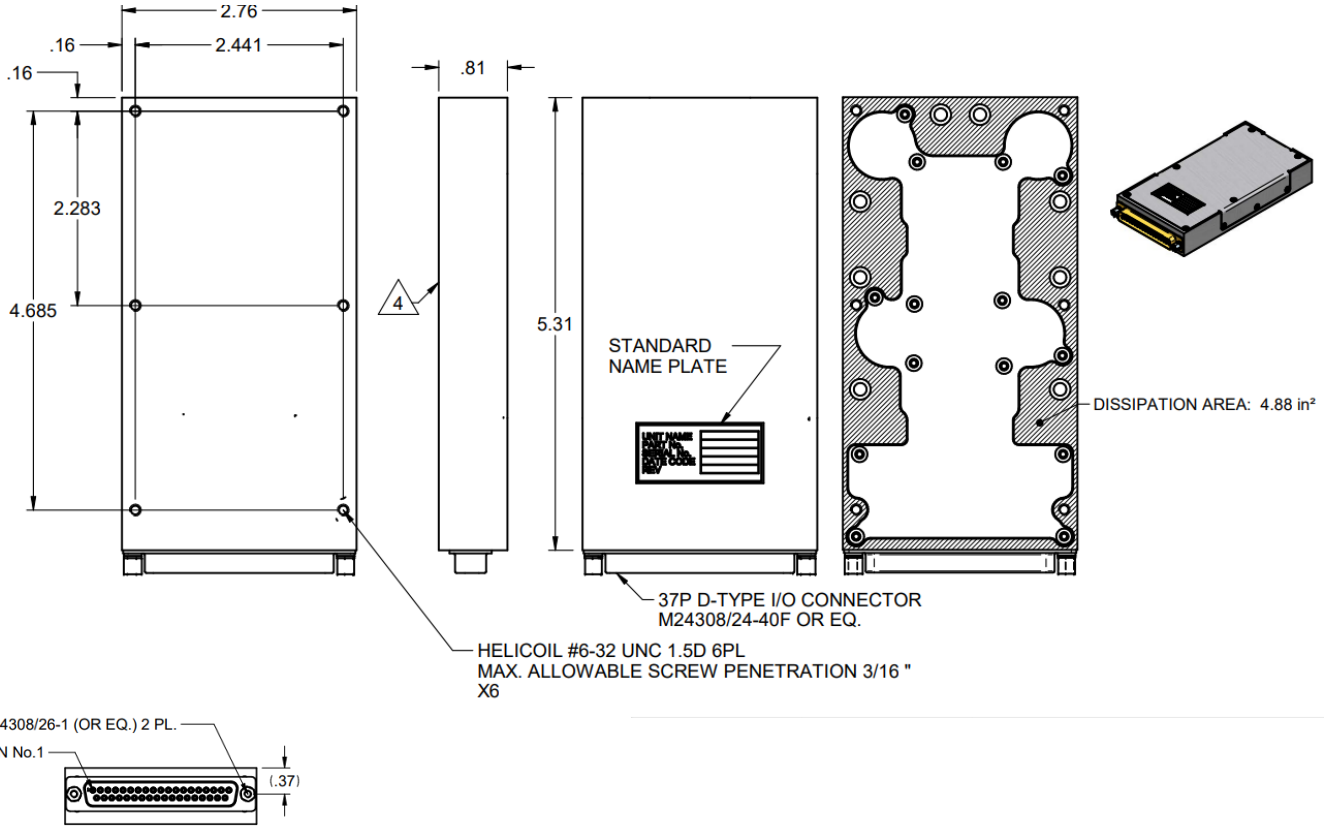

NOTES :

1. WORKMANSHIP SHALL BE MIL-STD-454, REQ. 9
2. CONVERSION COATING PER MIL-DTL-5541 LAST REV, TYPE I, CLASS IA
3. DISSIPATION AREA: 4.88 in²

Note: Specifications are subject to change without prior notice by the manufacturer.