

M3110 SERIES

3-PHASE AC/DC POWER SUPPLY



PRODUCT HIGHLIGHTS

- **ULTRA-LOW INPUT CURRENT THD**
- **HIGH POWER FACTOR**
- **HIGH EFFICIENCY**
- **SINGLE OUTPUT**
- **LAGGING POWER FACTOR OPTIONAL**
- **UP TO 1000 W**

M3110 SERIES 3-PHASE AC/DC POWER SUPPLY

Applications

Military (Airborne, ground-fix, shipboard), Ruggedized, Telecom, Industrial

Special Features

- High efficiency
- Wide input range
- Input / Output isolation
- Limited Inrush Current
- EMI filters included
- P.F. > 97% (75-100% load)
- THDI < 2% @ full load
- Remote On/Off
- Output Good signal (option)
- Indefinite short circuit protection with auto-recovery
- Over-voltage shutdown
- Over temperature shutdown with auto-recovery

Electrical Specifications

AC Input

Nominal:
115/200 V_{AC}, 47-440 Hz, 3-phase

Steady state:
100 to 130 V_{AC}
(173 to 225 V_{AC} Line to line)

Transients:
180 V_{AC} (312V_{AC} Line to line)/ 50 msec per MIL-STD-704

Full performances between 104 to 127V_{AC} (180 to 220V_{AC} Line-to-Line)

Output Voltage Regulation

Up to ±1% (no load to full load, over input voltage normal range, -40 °C to +71 °C)

Ripple and Noise

100–150 mV_{p-p}, typical (max. 1%) without external capacitance.

DC Output

Voltage range: 5 to 50 V_{DC}
Output power: up to 1000 W
Output Current: Up to 40A

Efficiency

88% Typical (nominal input, 28V_{DC} output, full load, room temperature)

Turn on Transient

No Voltage over shoot during power on.

Isolation

Input to Output: 500 V_{DC}
Input to Case: 500 V_{DC}
Output to Case: 100 V_{DC}

EMC

Complies with MIL-STD-461E: CE101, CE102, CS101, CS114, CS115, CS116, RE102, RS103

Power Factor

Lagging PF per MIL-STD-704F Optional.
Please consult factory for details.

M3110 SERIES 3-PHASE AC/DC POWER SUPPLY

*Protections and Properties**

Input

- **Inrush Current:**
Up to 0.09 A²sec (for circuit breaker selection purposes)
Up to 6 x I_{in,max} in the first 20 ms post energizing.
- **Phase loss detection:**
The unit disable in case of phase loss.

Output

- **Over Voltage Protection:**
Shutdown and latch at 10-20% above maximum voltage.
- **Current Limiting:**
Continuous protection less than 150% of the current rating.

General

- **Over Temperature Protection:**
Shutdown at base plate temperature of +100 °C ± 5 °C Automatic recovery at base plate temperature of +85 °C ± 5 °C.

Environmental Conditions

Designed to meet MIL-STD-810F

Temperature

Operating: -40 °C to +71 °C (at baseplate)
Storage: -55 °C to +125 °C

Altitude

Method 500.4, Procedure I & II:
Up to 70,000 ft. non-operational
Up to 50,000 ft. operational

Salt Fog

Method 509.4

Humidity

Method 507.4
Procedure I
Up to 95% RH

Vibration (random)

Method 514.5
Category 4 - General minimum integrity exposure
IAW Figure 514.5C-17
1 hour per axis.

Shock

Method 516.5
Procedure I
30 g, 11 ms terminal peak saw-tooth,

Reliability

74,677 hours, at +71 °C baseplate, Airborne Inhabited Fighter (AIF) environment.
37,128 hours, at +71 °C baseplate, Airborne Uninhabited Fighter (AUF) environment.
1,505,738 hours, at +25 °C baseplate, Ground Fixed (GF) environment.
Calculated IAW MIL-HDBK-217F Notice 2.

Environmental Stress Screening (ESS)

Including random vibration and thermal cycles is also available. **Please consult factory for details.**

* Thresholds and protections can be modified / removed – please consult factory.

M3110 SERIES 3-PHASE AC/DC POWER SUPPLY

Highlights and Typical Characteristics

Input Current Harmonics

Input: 3x 115 V_{rms} /

400 Hz Output: 28 V_{DC} /

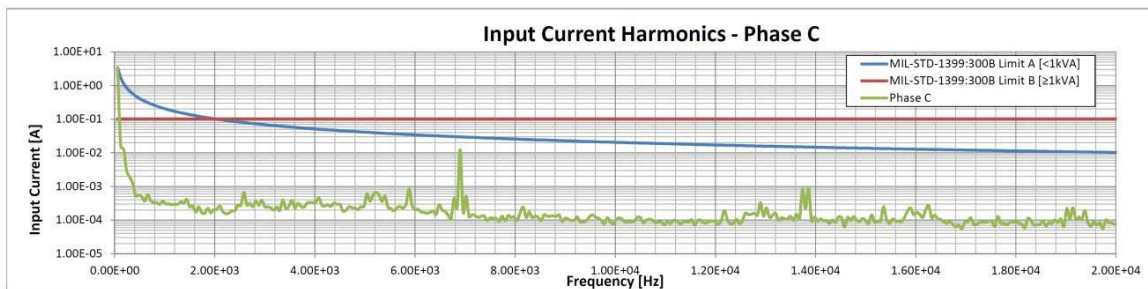
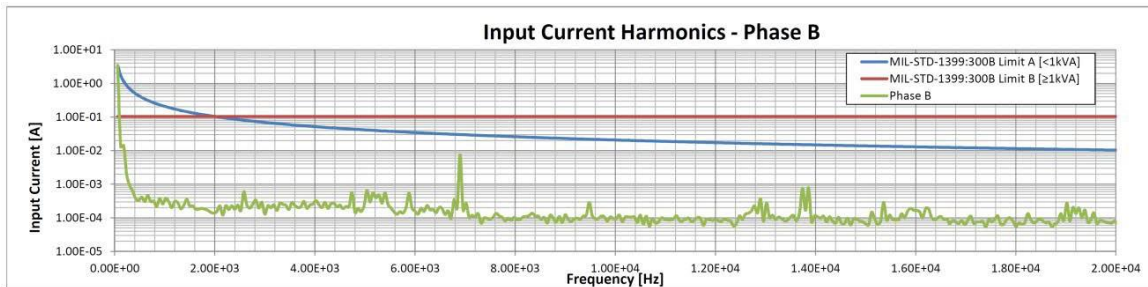
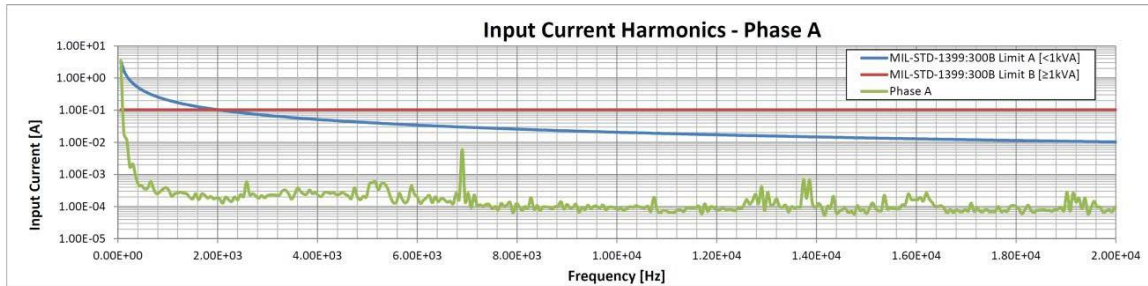

Power Factor and THDI vs. Load

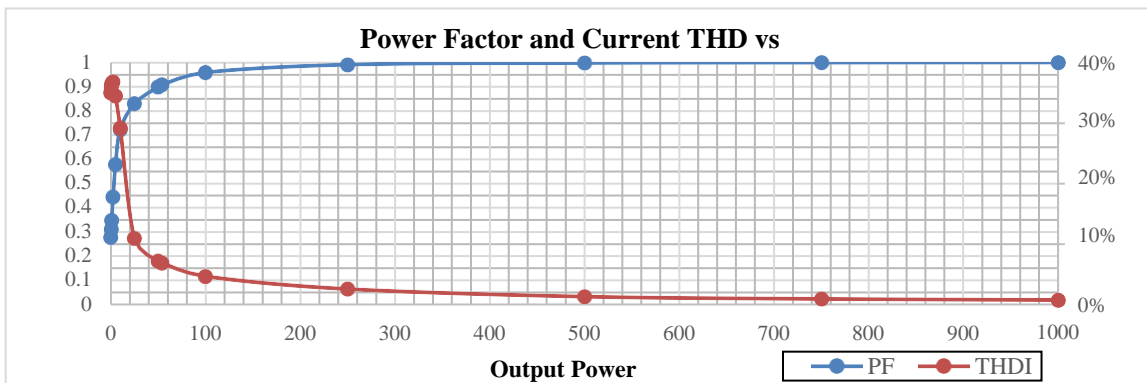

M3110 SERIES 3-PHASE AC/DC POWER SUPPLY

Pin Assignment Standard Version

J1 - Input Connector

Connector type: M24308/24-26F or eq.

Mates with: M24308/2-2F or eq.

Pin No.	Pin Function	Pin No.	Pin Function
1	PHASE A	9	PHASE A
2	PHASE A	10	CHASSIS
3	N.C.	11	N.C.
4	PHASE B	12	PHASE B
5	PHASE B	13	N.C.
6	N.C.	14	CHASSIS
7	PHASE C	15	PHASE C
8	PHASE C		

J2 - Signal Connector

Connector type: M24308/2-1F or eq.

Mates with: M24308/4-1F or eq.

Pin No.	Pin Function
1	REMOTE SENSE (+)
2	REMOTE SENSE (-)
3	N.C.
4	N.C.
5	N.C.
6	N.C.
7	N.C.
8	N.C.
9	REMOTE SHUTDOWN

M3110 SERIES 3-PHASE AC/DC POWER SUPPLY

Pin Assignment Optional

J1 - Input Connector

Connector type: M24308/24-26F or eq.

Mates with: M24308/2-2F or eq.

Pin No.	Pin Function	Pin No.	Pin Function
1	PHASE A	9	PHASE A
2	PHASE A	10	CHASSIS
3	N.C.	11	N.C.
4	PHASE B	12	PHASE B
5	PHASE B	13	N.C.
6	N.C.	14	CHASSIS
7	PHASE C	15	PHASE C
8	PHASE C		

J2 - Signal Connector

Connector type: M24308/2-1F or eq.

Mates with: M24308/4-1F or eq.

Pin No.	Pin Function
1	REMOTE SENSE (+)
2	REMOTE SENSE (-)
3	N.C.
4	Power Good RTN
5	N.C.
6	N.C.
7	N.C.
8	Power Good
9	REMOTE SHUTDOWN

Output studs

Two 10-32 studs

Polarity marked on unit

M3110 SERIES 3-PHASE AC/DC POWER SUPPLY

Functions and Signals

REMOTE SHUTDOWN signal

The SHDN signal is used to turn the power supply ON and OFF. OPEN will turn the power supply ON. 5V applied between pin 9 and pin 2 will turn the power supply OFF.

REMOTE SENSE signal

The SENSE is used to achieve accurate load regulation at the load (this is done by connecting the pins directly to the load).
The remote sense will compensate up to 2V or 10% of the nominal voltage, the lower of.
In case remote sense is not required, short the +SENSE pin to the +OUT stud and the -SENSE pin to the -OUT stud.

Power Good signal - Optional

Uncommitted collector and emitter of an opto-isolator.
Low ($V < 0.8$ @ 1mA, relative to Power Good RTN) indicates normal output voltage.
Open ($I < 0.1$ mA @ 5V) indicates low output voltage (due to over load, inhibited output or a failure).
Absolute maximum ratings (Power Good to Power Good RTN): -0.5V/+15V

Typical Connection Diagram

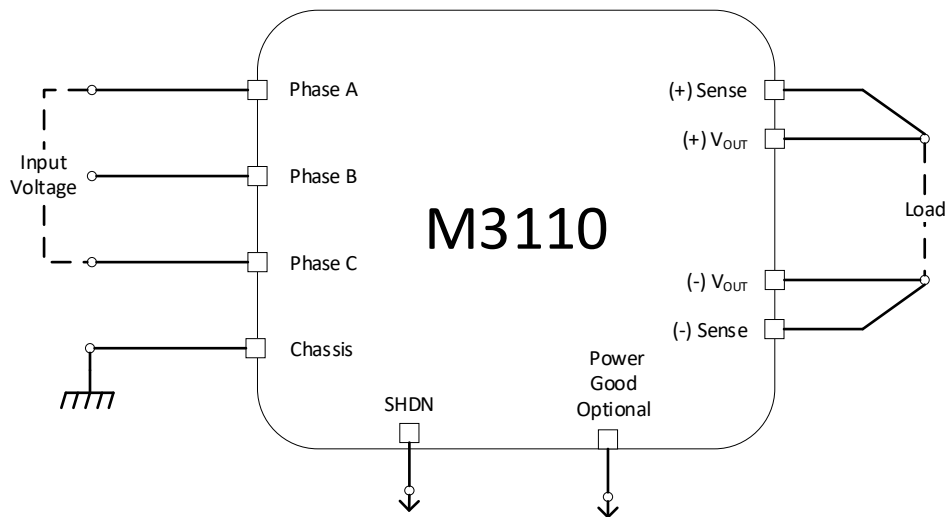

M3110 SERIES 3-PHASE AC/DC POWER SUPPLY

Outline Drawing

This figure is for reference only. For more details see Drawing M3110100

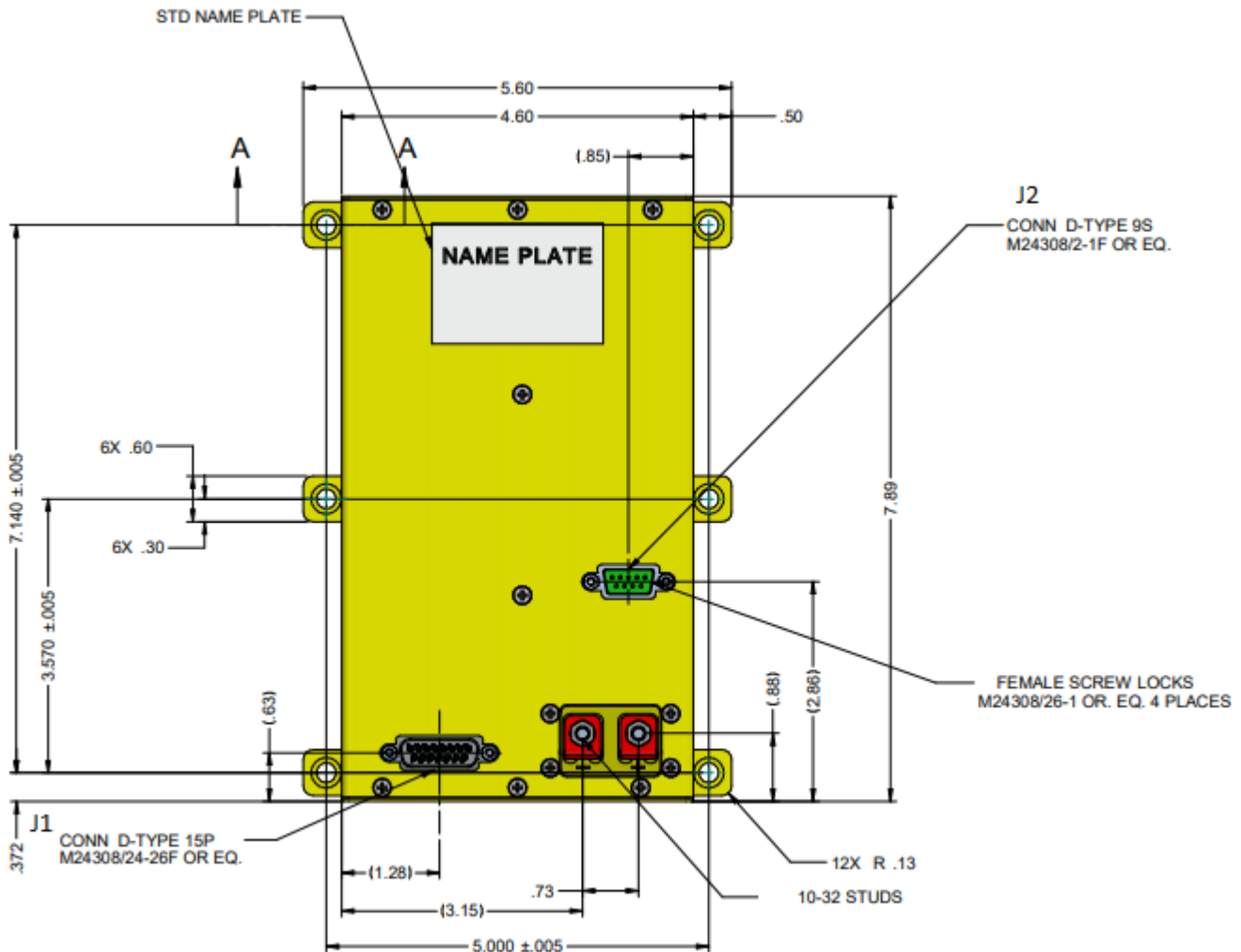
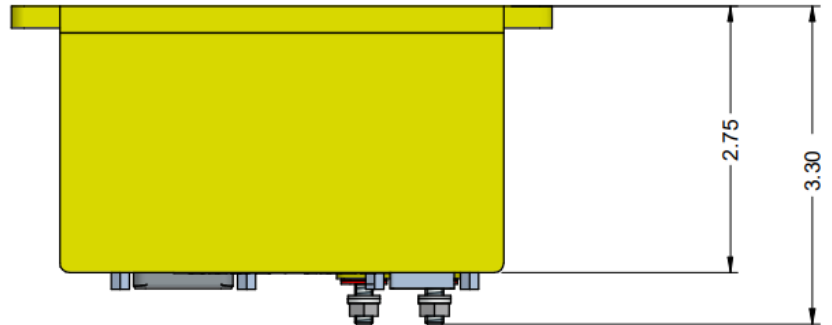
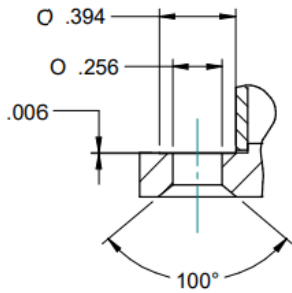

M3110 SERIES 3-PHASE AC/DC POWER SUPPLY

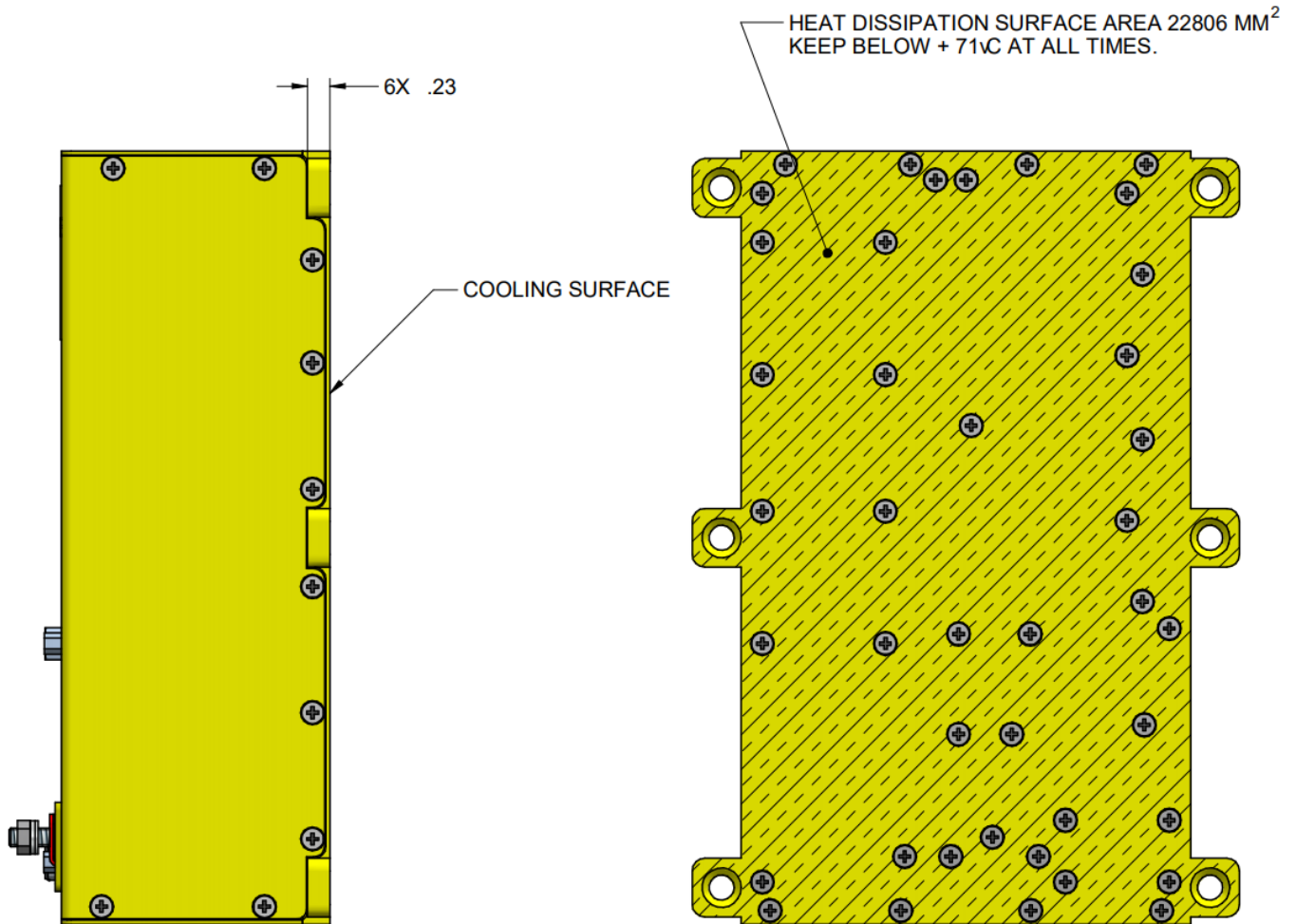

NOTES :

1. MTL. BODY : AL 6061-T651 COVERS : AL 5052-H32 OR EQ.
2. CONVERSION COATING PER MIL -C-5541 CL 3

Notes

Dimensions are in Inches

Tolerance is:

.XX ± 0.03 IN

.XXX ± 0.10 IN

Weight: Approx. 6 lbs [2.75 kg]

M3110 SERIES 3-PHASE AC/DC POWER SUPPLY

Standard Configurations

Part number	Input		Output		Special features
	Voltage range	Frequency	Voltage	Current	
M3110-100	3-phase, 104 to 127 V _{AC}	50/60/400 Hz	5 V _{DC}	40 A	
M3110-101	3-phase, 104 to 127 V _{AC}	50/60/400 Hz	12 V _{DC}	40 A	
M3110-102	3-phase, 104 to 127 V _{AC}	50/60/400 Hz	15 V _{DC}	40 A	
M3110-103	3-phase, 104 to 127 V _{AC}	50/60/400 Hz	24 V _{DC}	40 A	
M3110-104	3-phase, 104 to 127 V _{AC}	50/60/400 Hz	28 V _{DC}	36 A	
M3110-105	3-phase, 104 to 127 V _{AC}	50/60/400 Hz	48 V _{DC}	21 A	
M3110-106	3-phase, 104 to 127 V _{AC}	50/60/400 Hz	28 V _{DC}	36 A	Parallel operation via output voltage droop. Voltage regulation is ±3%.
M3110-107	3-phase, 104 to 127 V _{AC}	50/60/400 Hz	48 V _{DC}	21 A	Parallel operation via output voltage droop. Voltage regulation is ±3%.

Note: Specifications are subject to change without prior notice by the manufacturer